



LAYOUT REPORT OF ROOFTOP PROJECT

For 115 kWp

Name of Place
California

Date
13 October, 2014

Order No.
#1410130001

Client
abc

Email
ezysolare@gmail.com

Address
xyz
Mumbai, Maharashtra,
India
000000

INDEX

1.	Layout Review Page	3
2.	Methodology of Layout	4
3.	Summary	5
4.	Site Characteristics	5
5.	Project Features	6
6.	Site Design Plan	7
7.	Table Top View of a Site	8
8.	Overall Plan Layout	9

ABOUT EZYSOLARE

ezysolare is dedicated to making the journey of going solar easy. Starting from decision making to design, ezysolare breaks the process into 2 simple steps. We assist in ascertaining the feasibility of a solar project through SEAR (Solar Energy Assessment Report), while LAYOUT (Solar Module Layout) details the placement of modules and other key equipment of a solar power plant. Both our offerings are designed for all possible variations of projects - rooftop and ground mounted, MW and kW scale, crystalline and thin film modules promising users a tailor made solution to their unique requirements.

DISCLAIMER AND LEGAL INFORMATION:

Considering the nature of climate fluctuations, inter-annual and long-term changes, as well as uncertainty of measurements and calculations, ezysolare cannot take full guarantee of the accuracy of estimates. The maximum possible has been done based on the layout on the best available data, software and knowledge. Ezysolare shall not be liable for any direct, incidental, consequential, indirect or punitive damages arising or alleged to have arisen out of use of the provided report.

1. LAYOUT REVIEW PAGE

This is the review page of your layout form you filled and provided us the information to create your layout report.



Geo Coordinates

Latitude	33.9000015259 North
Longitude	117.900001526 East



Technical Specifications

Capacity	115 kW
Type of Area	Roof
Type of Roof	Flat
Links	-

Modules & Inverters

Set #	Item	Type	Make	Capacity
Set	Module	Polycrystalline	Canadian Solar	250.000 Wp
	Inverter	String	Danfoss	15.000 kW
	Remarks	-		

2. METHODOLOGY OF LAYOUT

Methodology that can be used for evaluation of the sites to create the Layout report include various attributes described below:

Shadow Analysis

Shading analysis is one of the most essential steps in phase of solar energy system design. In photovoltaic it is important to analyze shading caused by surrounding objects and/or vegetation. Shadow Analysis is the major parameter based on which we get the capacity of plant. However, other parameters like availability of land, energy requirement etc. are also considered for deciding the capacity of a plant.

Capacity, Pitch and Optimum tilt

Based on the Shadow Analysis or capacity given by our users We take the capacity of a site and calculate the pitch and optimum tilt of modules to get maximum sunlight from sun for energy generation through photovoltaic module.

Evacuation Location

General arrangement of equipment & facilities are in a way to ease out the evacuation of power to grid.

Stringing - Series, Parallel

Based on the voltage range of modules & inverters the string sizing (Number of modules in Series & parallel) will be determined.

Table Size finalization

Based on the strings, table size is finalized & same size of the table is kept to insure the repeatability of the racking arrangement for easy sourcing.

Inverter Location

Inverter location is generally governed by optimized cable lengths to keep losses as minimum as possible.

Lightning Arrester Placement

Lightning Arrester is positioned to cover the complete installed area factoring in the shadow of Lightning Arrester.

3. SUMMARY

This layout report is proposed to develop a Solar Photovoltaic power plant with maximum generation capacity of 105 kW AC capacity & 115 kWp installed capacity located at site California.

4. SITE CHARACTERISTIC

Project Location California

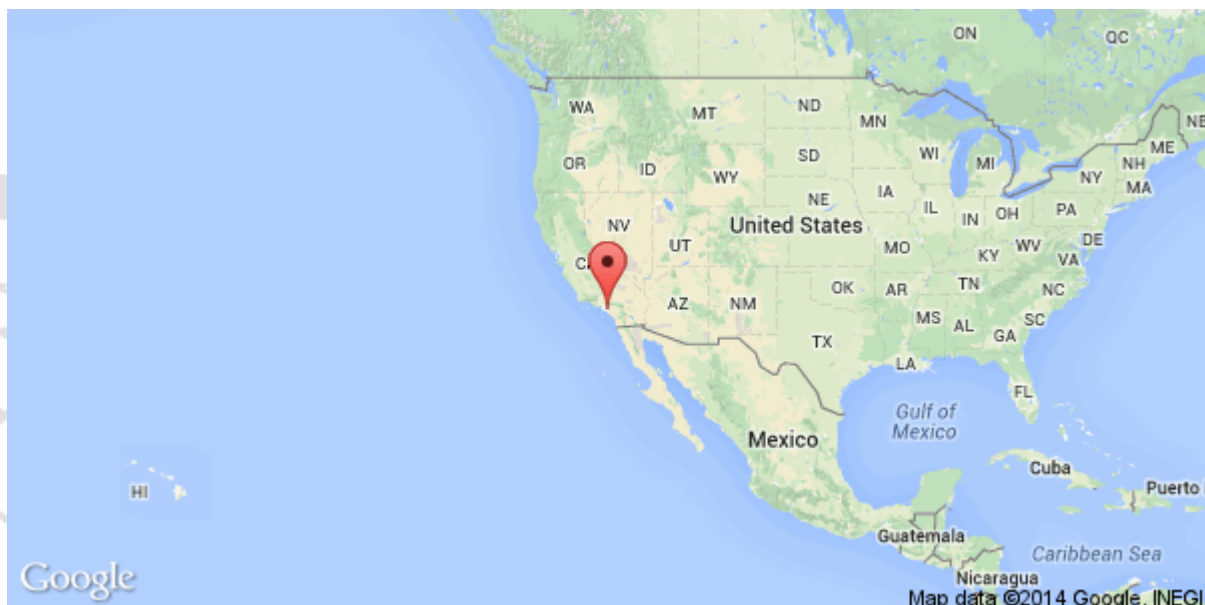
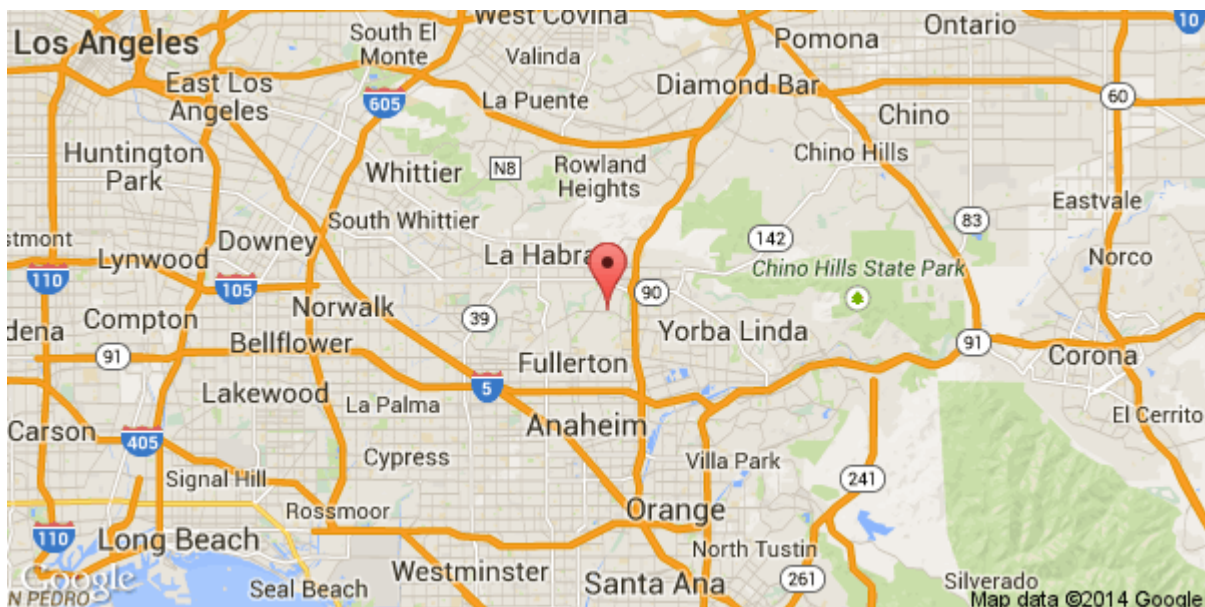

5. PROJECT FEATURES

Parameters	Details
Project Location	California
Latitude & Longitude	33.900 North, 117.900 West
Tilt Angle	29 °
Pitch Distance	7.0 m
Estimated Total Area	2875 Sq.M
Installed Capacity	115 kWp
Module Make & Wattage	Canadian Solar, 250 kWp
Total No. of modules	460
Inverter Make & Capacity	Danfoss, 15 kW
Number of Inverter Used	7
AC Capacity	105 kW

6. SITE DESIGN PLAN

Site Features	Description	BOM
Existing Features	Existing features are those, which already exist on site.	N.A
PV Module	PV module converts solar radiation into direct current (DC) electricity through photovoltaic effect. The panels will be mounted and aligned in rows facing due south and will be mounted.	460 number of PV panels of 250 Wp, Canadian Solar CS 65-250 P panels. Dimensions: Length: 1638 mm , Width: 982 mm , Thickness: 36 mm.
Inverter	From the combiner box, the DC current will be transmitted to one of given inverter units (enclosed), which will convert the DC electricity into AC electricity suitable for evacuating to the local grid.	7 number of inverters units, Danfoss, FLX Pro 15, 105 kW of continuous output power and will contain 7 15 kW inverters.
Lightning Arrester	A lightning arrester is a device used to protect the insulation and conductors of the system from the damaging effects of lightning.	One Lightning Arrestors of 65 m radius has been considered.

7. TOP VIEW OF A SITE

This is the top view of the site for which Solar Module Layout has been designed.

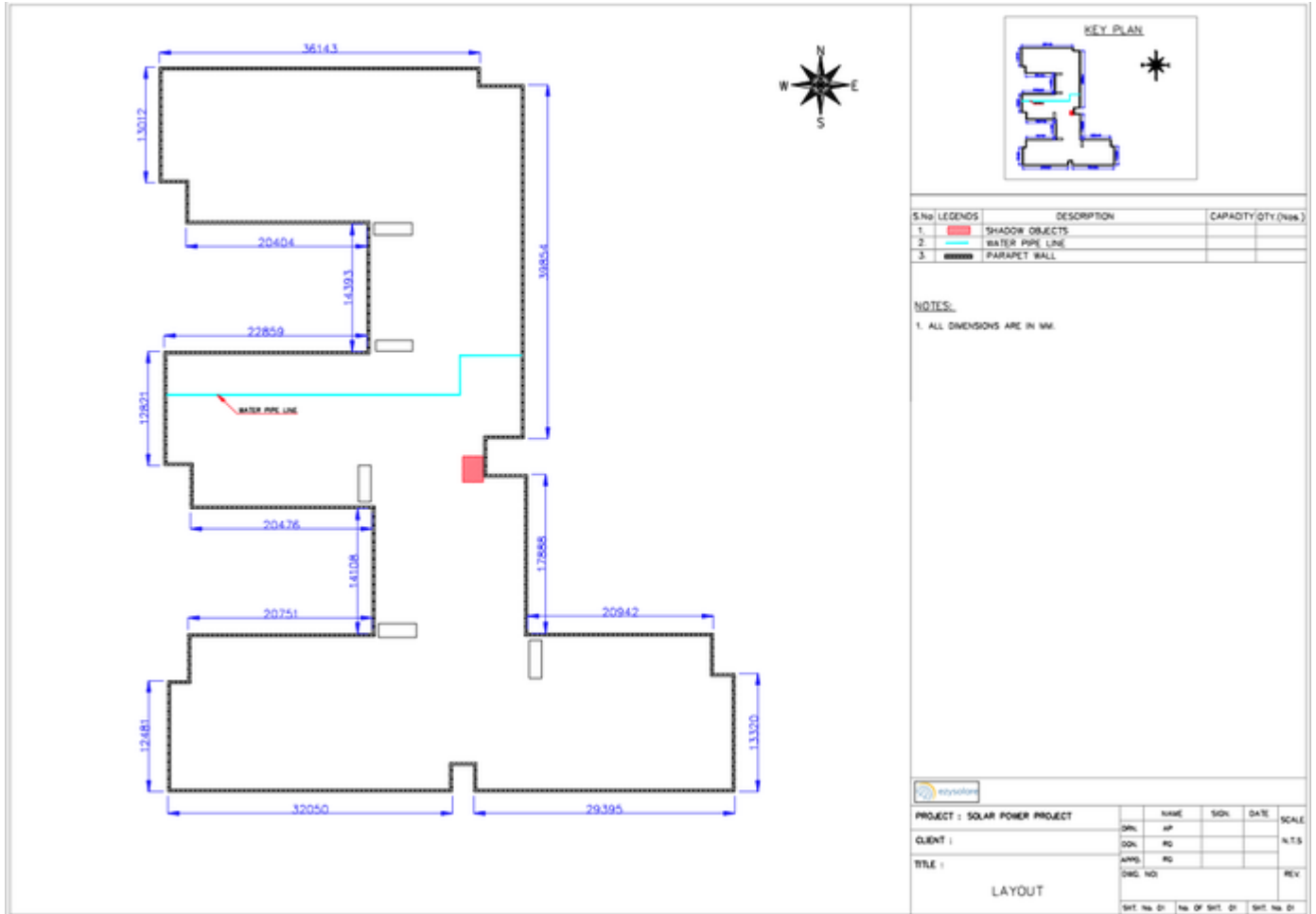

8. OVERALL PLANT LAYOUT

This is the overall plant layout with Modules, inverters & Lightning arresters placed at your site.

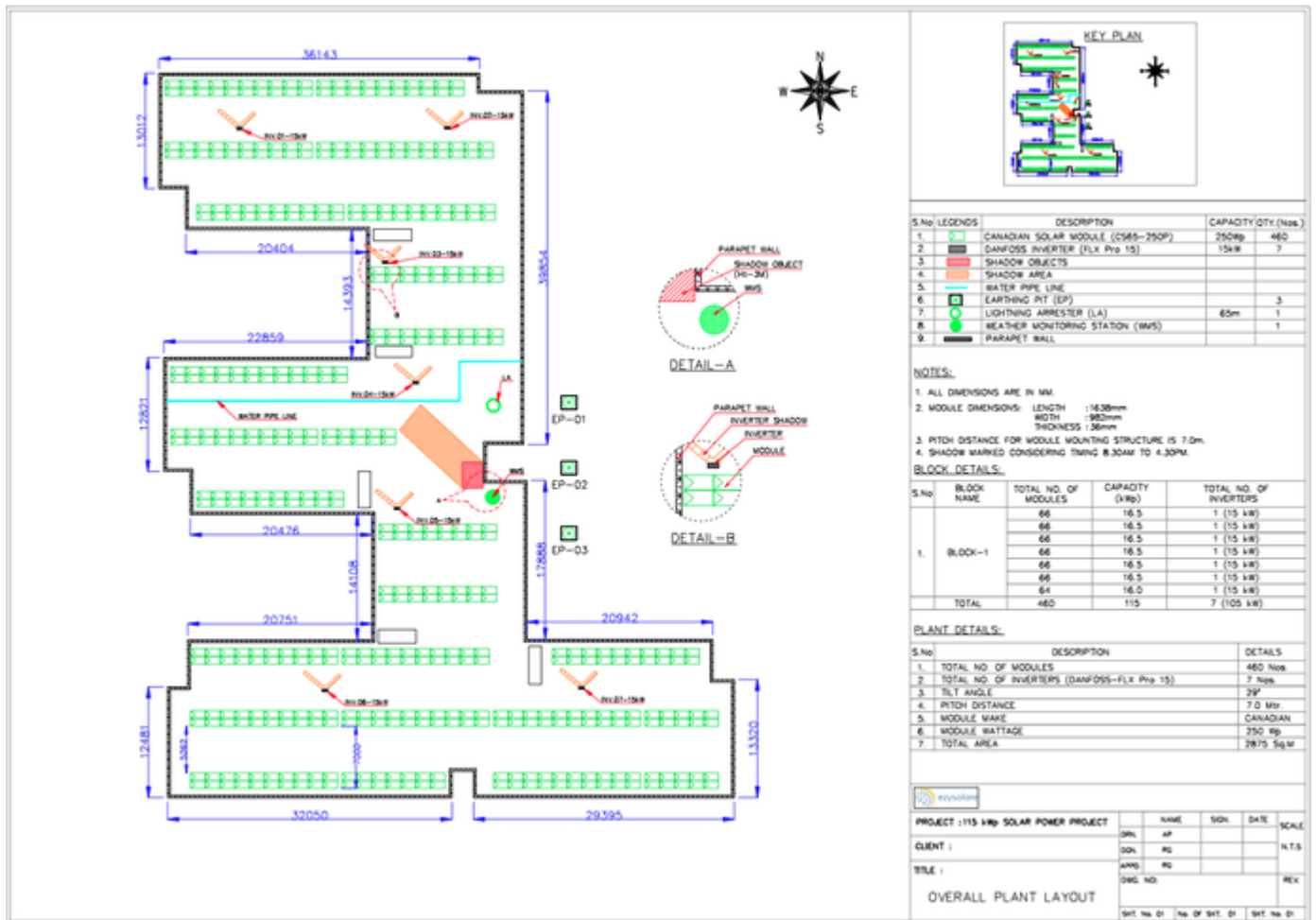



108, Pinnacle Business Park , Corporate Road, Prahladnagar , Ahmedabad, Gujarat - 380015

 [company/ezysolare](https://www.linkedin.com/company/ezysolare)

 [pages/Ezysolare/506233432835389](https://www.facebook.com/pages/Ezysolare/506233432835389)

 [ezysolare](https://twitter.com/ezysolare)

 [u/0/106466619653569381444/posts](https://plus.google.com/u/0/106466619653569381444/posts)

 info@ezysolare.com

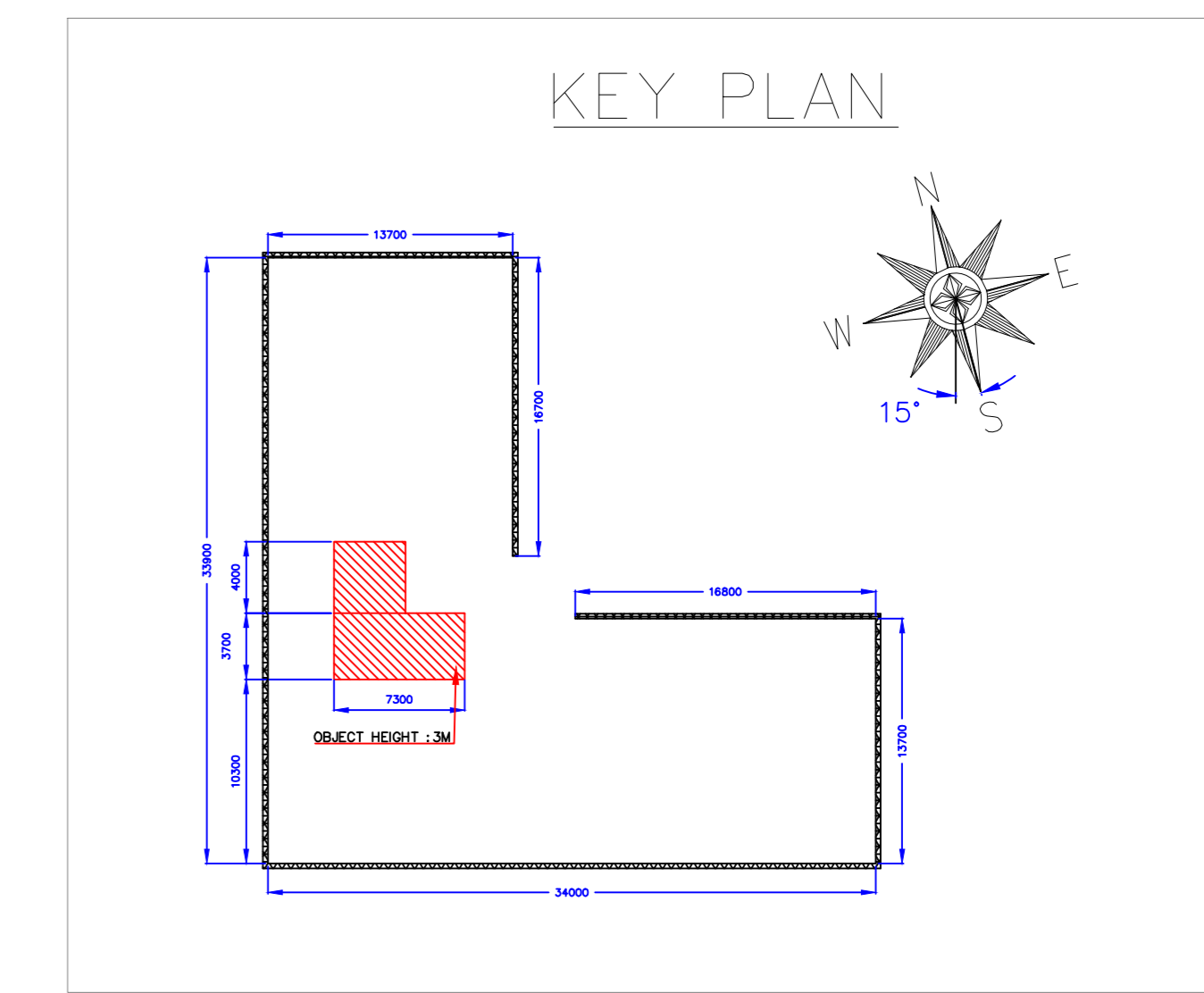
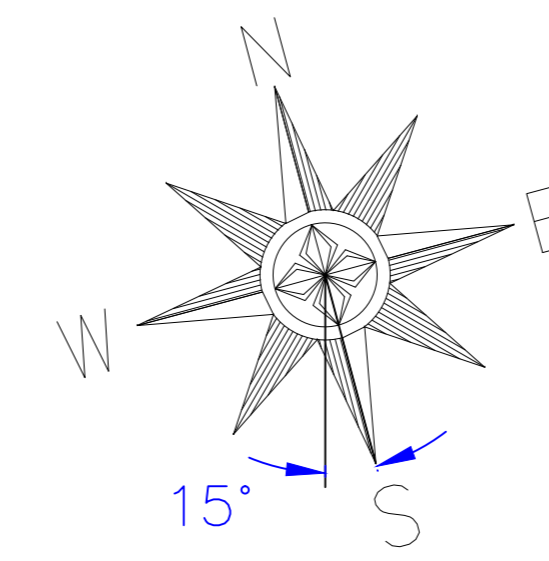
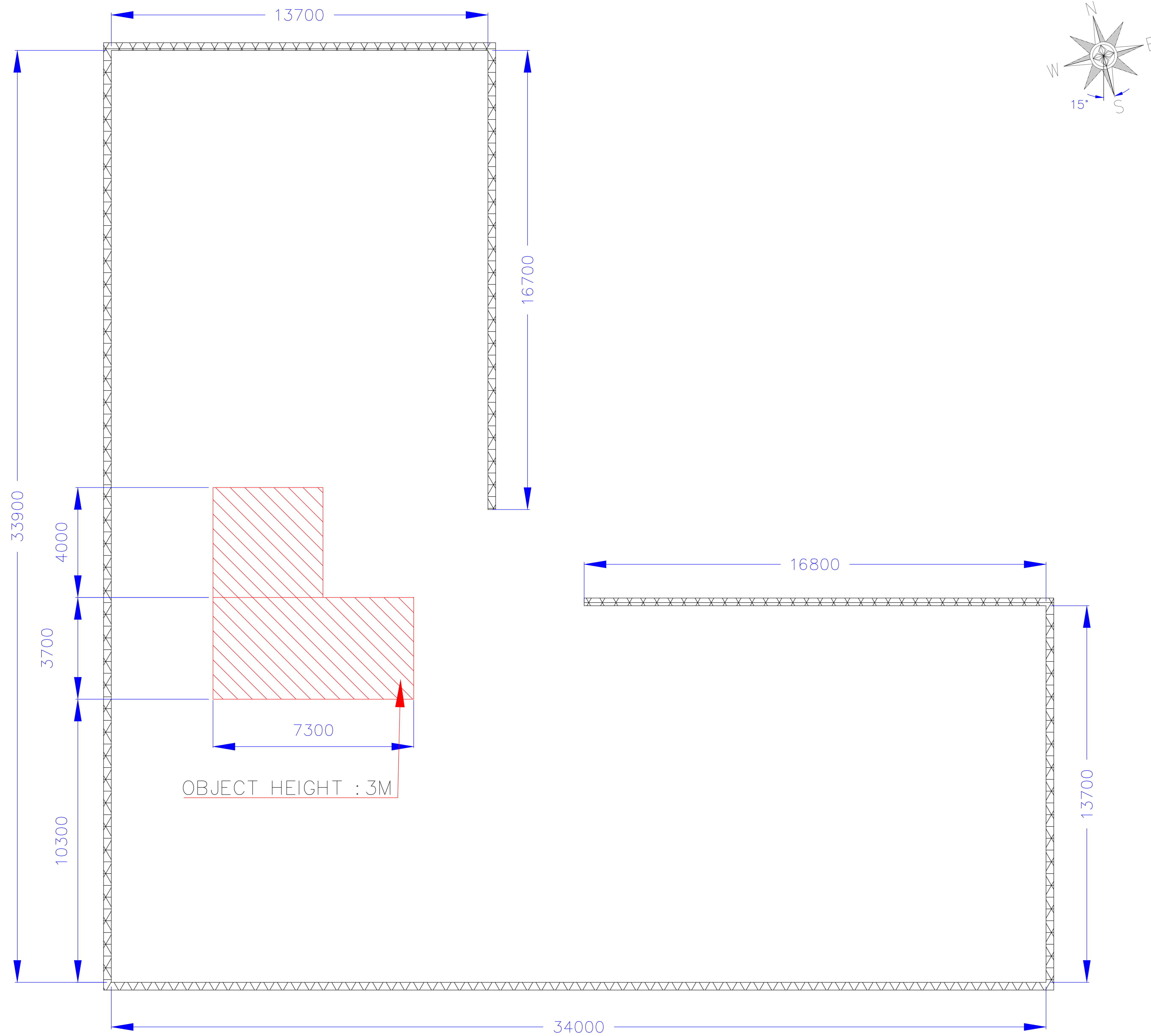

S.No	LEGENDS	DESCRIPTION	CAPACITY	QTY.(Nos.)
1.		SHADOW OBJECT		
2.		PARAPET WALL		

NOTES:

1. ALL DIMENSIONS ARE IN MM.



PROJECT : SOLAR POWER PROJECT	NAME	SIGN.	DATE	SCALE
CLIENT :	DRN. AP			N.T.S
TITLE :	DGN. RG			
	APPD. RG			REV.
	DWG. NO:			
	SHT. No. 01	No. OF SHT. 01	SHT. No. 01	

LAYOUT

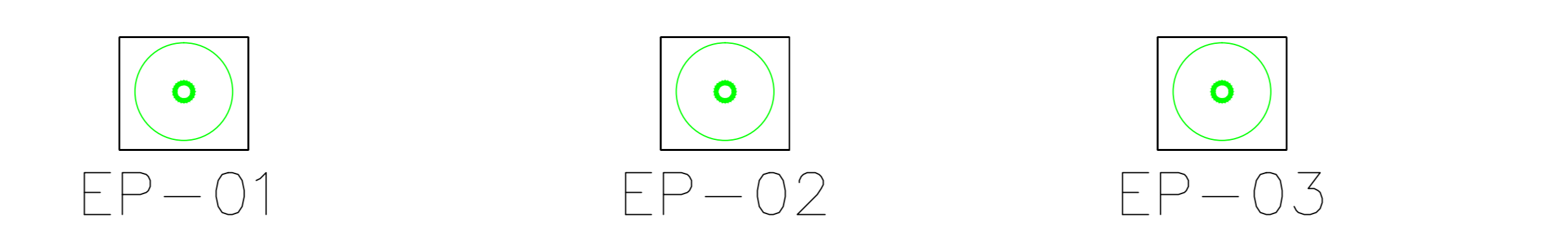
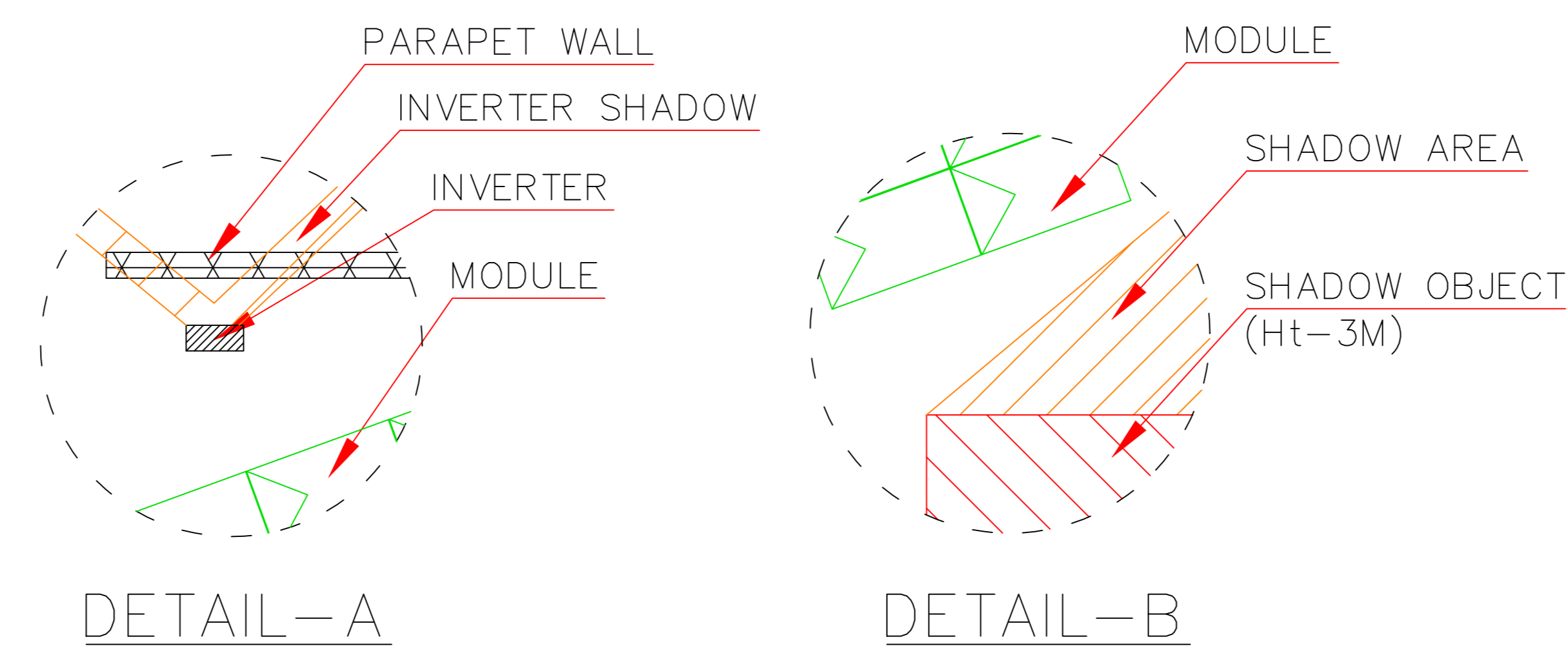
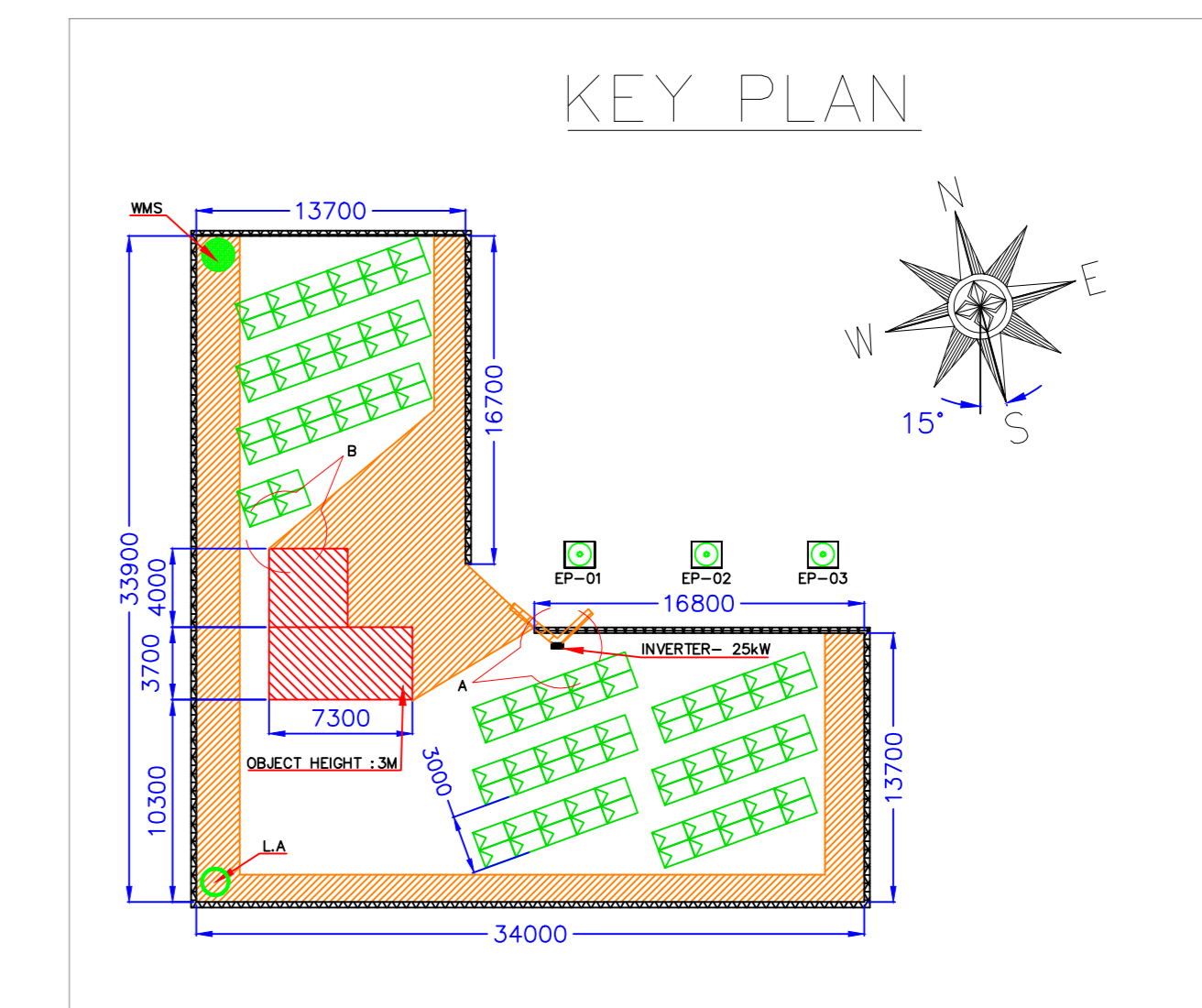
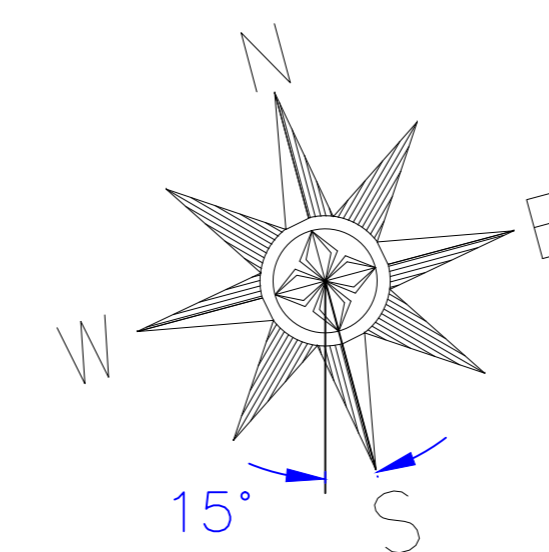
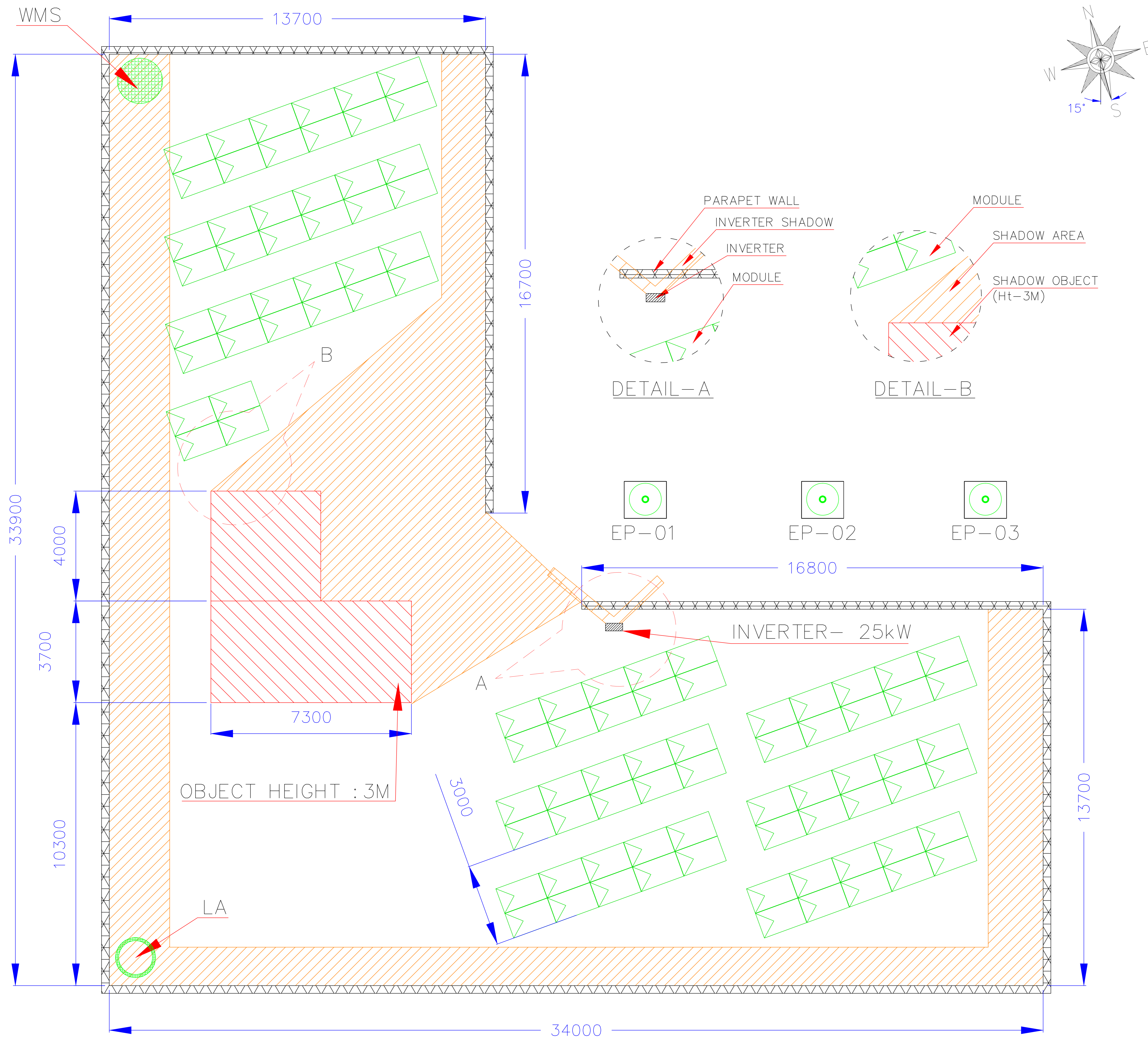

S.No	LEGENDS	DESCRIPTION	CAPACITY	QTY.(Nos.)
1.		VIKRAM SOLAR MODULE (ELV-250)	250Wp	100
2.		KACO INVERTER (TL3M)	25kW	1
3.		SHADOW OBJECT		
4.		SHADOW AREA		
5.		EARTHING PIT (EP)		
6.		LIGHTNING ARRESTER (LA)	50m	1
7.		WEATHER MONITORING STATION (WMS)		
8.		PARAPET WALL		

- NOTES:
- ALL DIMENSIONS ARE IN MM.
 - MODULE DIMENSIONS: LENGTH :1639mm
WIDTH :982mm
THICKNESS :36mm
 - PITCH DISTANCE FOR MODULE MOUNTING STRUCTURE IS 3.0m.
 - SHADOW MARKED CONSIDERING TIMING 8.30AM TO 4.30PM.

PLANT DETAILS:

S.No	DESCRIPTION	DETAILS
1.	TOTAL NO. OF MODULES	100 Nos.
2.	TOTAL NO. OF INVERTERS (KACO-TL3M-25kW)	1 No.
3.	TILT ANGLE	15°
4.	PITCH DISTANCE	3.0 Mtr.
5.	MODULE MAKE	VIKRAM
6.	MODULE WATTAGE	250 Wp
7.	TOTAL AREA	747 Sq.M



PROJECT : 25 KWp SOLAR POWER PROJECT	NAME	SIGN.	DATE	SCALE
CLIENT :	DRN. AP			N.T.S
TITLE :	DGN. RG			
	APPD. RG			
	DWG. NO:			REV.
	SHT. No. 01	No. OF SHT. 01	SHT. No. 01	

OVERALL PLANT LAYOUT